

Installation Instructions

Safety Speed Monitor

SV MRO

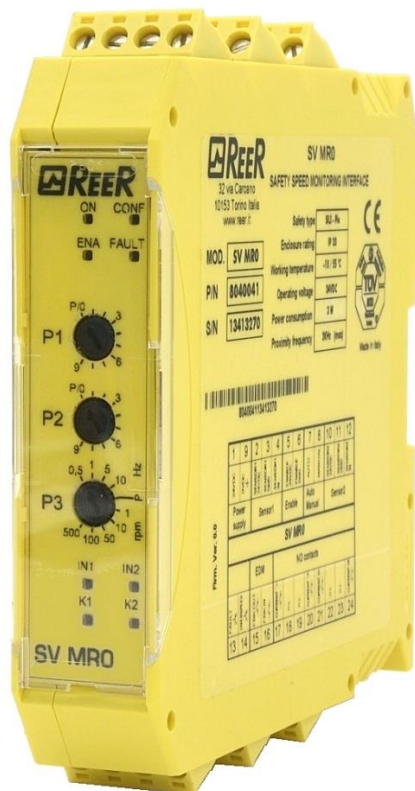

(Original instructions)



Contents

Preliminary note.....	3
Symbols used	3
Safety instructions	4
General requirements on the safety-related functions	4
Operation	5
General function description	5
Switching function: overspeed.....	5
Hysteresis.....	6
Initialisation.....	6
Installation.....	7
Mechanical installation of the device	7
Electrical Connections	8
Terminals	8
Set up of the device	10
Automatic/Manual mode selections.....	13
Enable input:	16
Technical data SV MRO.....	17
Definition of the LED's	18
Faults (blinkings)	18
Additional notes	19
Pulse inputs, pulse pick-ups.....	19
Switching outputs:	19
Restart command:.....	19
Fault output:.....	19
Overspeed output:	19
Feedback circuit:.....	19
Checklist after installation.....	19
Application Note	20
Warranty.....	22
EC Declaration of Conformity.....	23
UKCA Declaration of Conformity.....	24

PRELIMINARY NOTE

The instructions are part of the unit. They are intended for authorised persons according to the EMC and Low Voltage Directive and safety regulations.

The instructions contain information about the correct handling of the product. Read the instructions before use to familiarise yourself with operating conditions, installation and operation. Adhere to the safety instructions.

SYMBOLS USED

▶ Instructions

> Reaction, result

→ *Cross-reference*



Important note
Non-compliance can result in malfunction or interference



Information
Supplementary note

OVERSPEED Exceeded maximum programmed speed.

Safety instructions

Follow the operating instructions.

- Improper use may result in malfunctions of the unit. This can lead to personal injury and/or damage to property during operation of the machine. For this reason note all remarks on installation and handling given in these instructions. Also adhere to the safety instructions for the operation of the whole installation.
- In case of non-observance of notes or standards, specially when tampering with and/or modifying the unit, any liability and warranty is excluded.
- The unit must be installed, connected and put into operation by a qualified electrician trained in safety technology.
- The applicable technical standards for the corresponding application must be complied with.
- For installation the requirements according to EN 60204 must be observed.
- Connect and lay all cables according to EN ISO 13849-2 D.5.2 (Safety of machinery - Safety-related parts of control systems).
- In case of malfunction of the unit please contact the manufacturer. Tampering with the unit is not allowed.
- Disconnect the unit externally before handling it. Also disconnect any independently supplied relay load circuits.
- After setup the system has to be subjected to a complete function check.
- Use the unit only in specified environmental conditions (→ Technical data). In case of special operating conditions please contact the manufacturer.
- Use only as described below.

GENERAL REQUIREMENTS ON THE SAFETY-RELATED FUNCTIONS

The device complies with the functional and organisational requirements of EN ISO 13849-1 Performance-Level "e" and of EN 62061 SIL "3".



To maintain Safety Integrity Level (SIL) "3" requirements the two input sensors shall be independent.

Common cause failures between measuring sensors must be excluded by observing an appropriate cable installation (i.e. separate cable paths).



To maintain the category 4 requirements during longer periods of standstill, a forced dynamisation (t<24h) has to be carried out.

Operation

GENERAL FUNCTION DESCRIPTION

The speed monitor is a two-channel pulse evaluation system for safe overspeed detection.

To do so, it receives the pulse sequences from the pulse pick-ups connected to the inputs. The module calculate the resulting frequency.

By continuously comparing the input frequency (actual value) and the switch point (preset value) the evaluation system promptly detects overspeed of the set switch point, and the output relays switch according to the preset switching function.

The preset value is achieved by setting the 3 switches located in front of the module. The value can be set in "rpm" or "Hz" unit.

The device complies with the functional and organisational requirements of EN ISO 13849-1 Performance-Level "e" and of EN 62061 SIL "3".

SWITCHING FUNCTION: OVERSPEED

The output relays de-energise when the event occurs (selected frequency F_o reached). The relays switch on again when the value falls below the preset value decreased of hysteresis (F_{oh}). The NO contacts of the internal relays are connected in "series" and connected to the terminals. If both relays are energised, the current paths are closed so that (e.g.) a power contactor can be controlled.

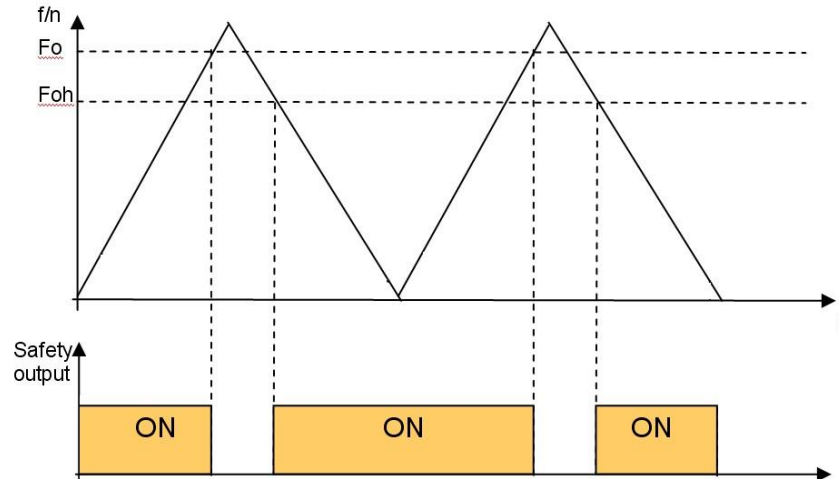

If the switch point is exceeded, the current paths open.

HYSTERESIS

The hysteresis determines the distance between the switch point (open the current paths) and the switch-on point (close the current paths).

The hysteresis value is fixed at 5 %.

If the input frequency falls below the set switch point by 5 %, the relays energise again and the current paths are closed.

Example with switch point $F_o = 1000$ (rpm):

- the current paths open when F_o has been exceeded (rising frequency)
- the current paths close when the measured value is lower than F_{oh} (in this case 950 rpm) (falling frequency) as in the drawing in "Switching function: overspeed".

INITIALISATION

Directly after power on, the SV MRO carries out an initialisation comprising a complete self-test.

After approx. 3 s the SV MRO is ready for operation.

INSTALLATION

Mechanical installation of the device

- ▶ Mount the device on a DIN rail in a housing protected against dust and humidity (min. IP 54).



Leave enough space between the unit and the top and bottom of the housing to enable air circulation and to avoid excessive heating.



Take into account the internal heating of all units when mounting several units side by side. The environmental conditions must be observed for every unit and, in order to avoid overheating, maintain between them one minimal distance of 2cm.

- ▶ Fasten the units to the rail.
- ▶ Lock it first on the upper side of the rail.
- ▶ Pull down the locking latch on the back of the unit.
- ▶ Press the unit gently and release the latch until you feel it snap into place.

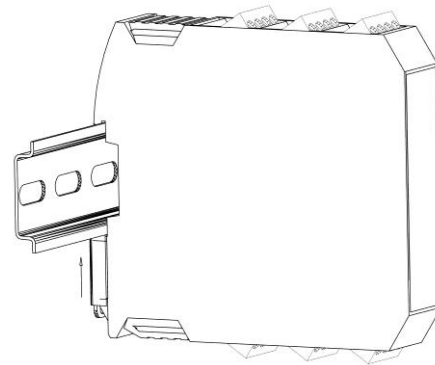
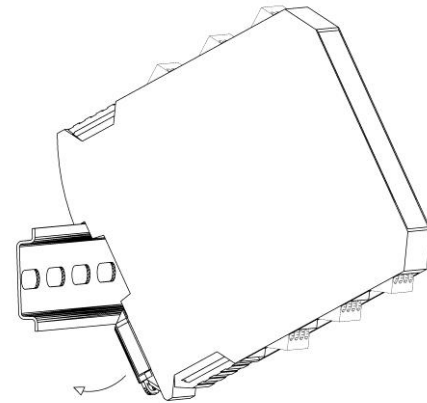

- ▶ To remove a unit, use a screwdriver to pull down the locking latch on the back of the unit; then lift the unit upwards and pull.

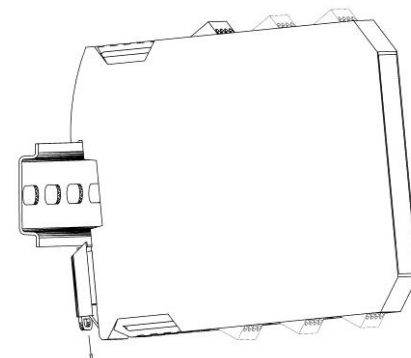

Electrical Connections

Voltage supply sensors:	+24VDC: max. 70mA, protected (by a resettable fuse at T=20 °C), short-circuit proof, not monitored. Ground: directly connected to the device ground.
Sensors:	PNP sensors, bounce-free.
Feedback circuit:	Yes - Max. 100 mA, short-circuit proof.
Enable input:	Yes - Via the enable input is possible to switch off the limit value monitoring.
Diagnostic output:	Positive switching transistor output. Max. 100mA, short-circuit proof.
Fault output:	Positive switching transistor output. Max. 100 mA, short-circuit proof.
Enable path:	2 x NO - Potential free - Max. 6A (protected with external 3.6 A).

Supply voltage



Connect the supply voltage of the device to terminals L+ and L-.

The nominal voltage is 24VDC. This voltage may vary between 19.2 V and 28.8 V incl. 5% residual ripple.

PELV power supplies are to be used (EN 60204-1).

TERMINALS

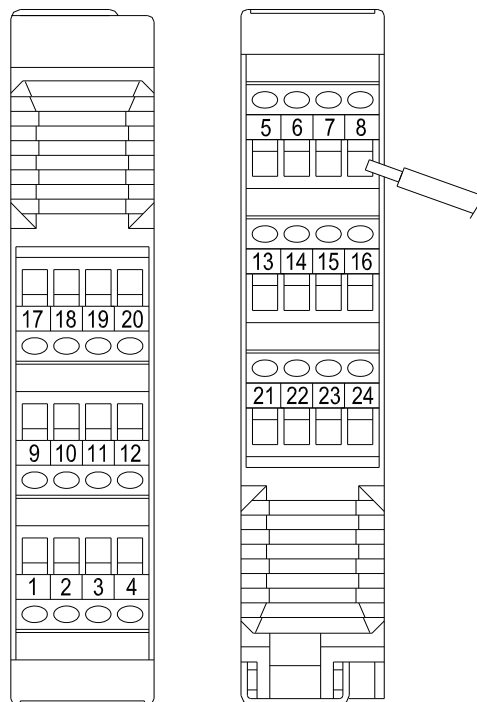

The electrical input signals meet the requirements of EN61131.



Terminal tightening torque: 5÷7lb-in (0,6÷0,7 Nm).

Terminal connection: "UPPER SIDE"		
A1	1	Operating voltage (+24VDC)
	2	Sensor1 supply (+24VDC)
	3	Sensor1 supply (GND)
	4	Sensor1 input
A2	9	Operating voltage (GND)
	10	Sensor2 supply (+24VDC)
	11	Sensor2 supply (GND)
	12	Sensor2 input
A3	17	current path 1A (relay contacts)
	18	-
	19	-
	20	current path 1B (relay contacts)
Terminal connection: "LOWER SIDE"		
C1	5	enable plus-switching
	6	enable ground-switching
	7	Automatic mode selection
	8	Manual mode selection
C2	13	transistor output "Fault" → (Fault output (13))
	14	transistor output "Overspeed" → (Overspeed output (14))
	15	feedback circuit output
	16	feedback circuit input
C3	21	current path 2A (relay contacts)
	22	-
	23	-
	24	current path 2B (relay contacts)



The relay contacts of the module shall be supplied by the same source.

Set up of the device

After the first power on of the device it is necessary to configure the Overspeed Frequency (Fo) using the three decade switches located in front of SV MRO.

The switches allow the user to enter the value of the desired preset frequency (as described below).

Switch point selection description

The switch point is selectable by means of 3 "decade switches" (270° potentiometer, 10 positions, locking).

- ▶ With P1 and P2 switches numerical values from 01 to 99 can be set (switch 1 with increments of 10, switch 2 with increments of 1).
- ▶ With a third switch (P3) the multiplier is set. The numerical values are multiplied with these factors and thus provide the actual switch point value. The multipliers have the unit "rpm" or Hz".













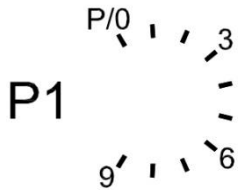



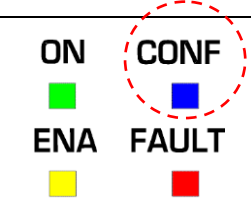



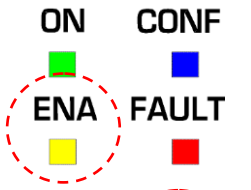



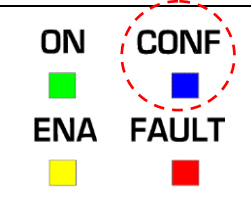
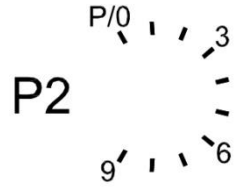



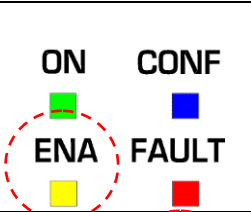

The unit *rpm* is only applicable when 1 cam/revolution is present.

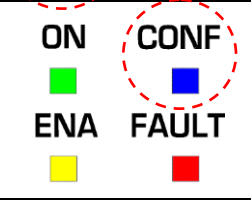
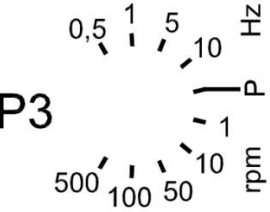

To select the desired value, at the power ON, the 3 switches must be in the "P" position.

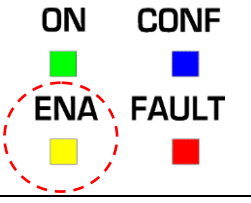

In order to not damage the potentiometers use a screwdriver of the appropriate size.

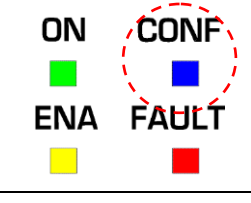
SWITCH	OPERATION / RESULT	LED
Start of configuration: ▶ Set the 3 switches to configuration position 0/P ▶ Switch on the power supply of the device		
	> The LED CONF is blinking ▶ Adjust Potentiometer P1 from the position 0/P to the needed Value	ON  CONF  ENA  FAULT  
	> During the rotation, the led ENA lapse by every Step (check with this visualization the corrected value)	ON  CONF  ENA  FAULT  
	> System resting in Configuration-Mode Waiting for input P2 > The LED CONF is still blinking	ON  CONF  ENA  FAULT  
	▶ Adjust Potentiometer P2 From the position 0/P to the needed Value > During the rotation, the led ENA lapse by every Step.	ON  CONF  ENA  FAULT  
	> System resting in Configuration-Mode Waiting for Input P3 > The led CONF is still blinking	ON  CONF  ENA  FAULT  
	▶ Adjust Potentiometer P3 From the position P to the needed Value > During the rotation, the led ENA lapse by every Step > Led CONF becomes fixed.	ON  CONF  ENA  FAULT  
	▶ Wait until led CONF is blinking twice (memorization) ▶ Turn OFF the power	ON  CONF  ENA  FAULT  
End of configuration		



All the 3 switches must be moved at least one time to select a correct value even if the selected value is "0" (correspondent to the "0/P" position).

Examples

The switch point value can only be set when operating voltage is connected to the device and the three switches are set as indicated (*factory setting*).

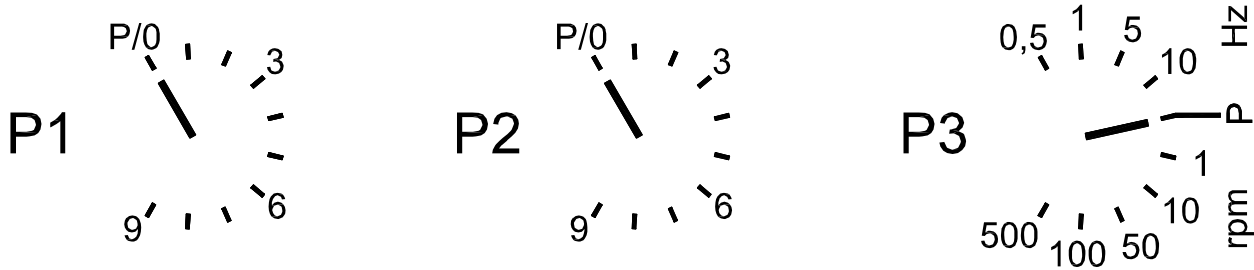

Figure 1 - Factory setting

Set P1, P2 and P3 to obtain the switch point value. Examples:

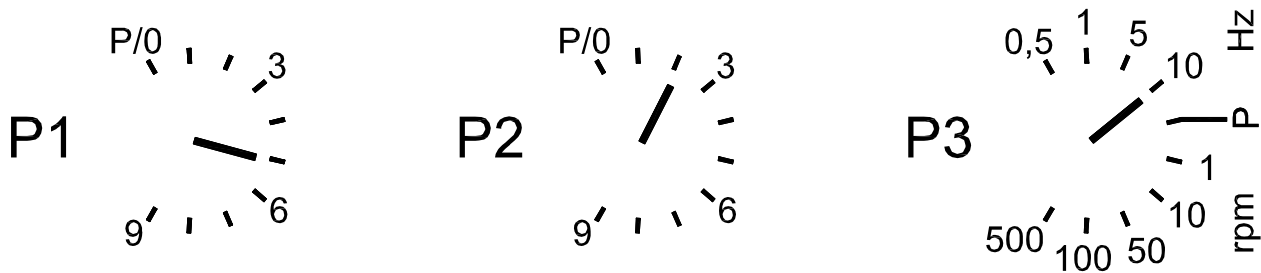

Figure 2 - Example 1: 520Hz

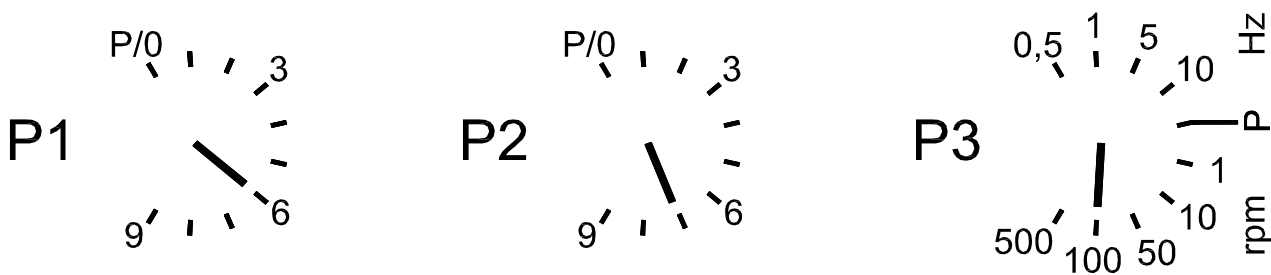

Figure 3 - Example 2: 6700rpm

AUTOMATIC/MANUAL MODE SELECTIONS

If overspeed is detected, the current relay paths open and the drive is switched off. This results that the input frequency falling again below the switch point and the current paths closing (below F_{oh}).

By means of the Automatic/Manual function it can be prevented that the current paths close when the measured value falls again below F_{oh} .

Set the Automatic/Manual function by connections during the installation.

The selection of the operative mode between Automatic or Manual is made by two input terminals 7 and 8. In figures below the two possible selections are showed.

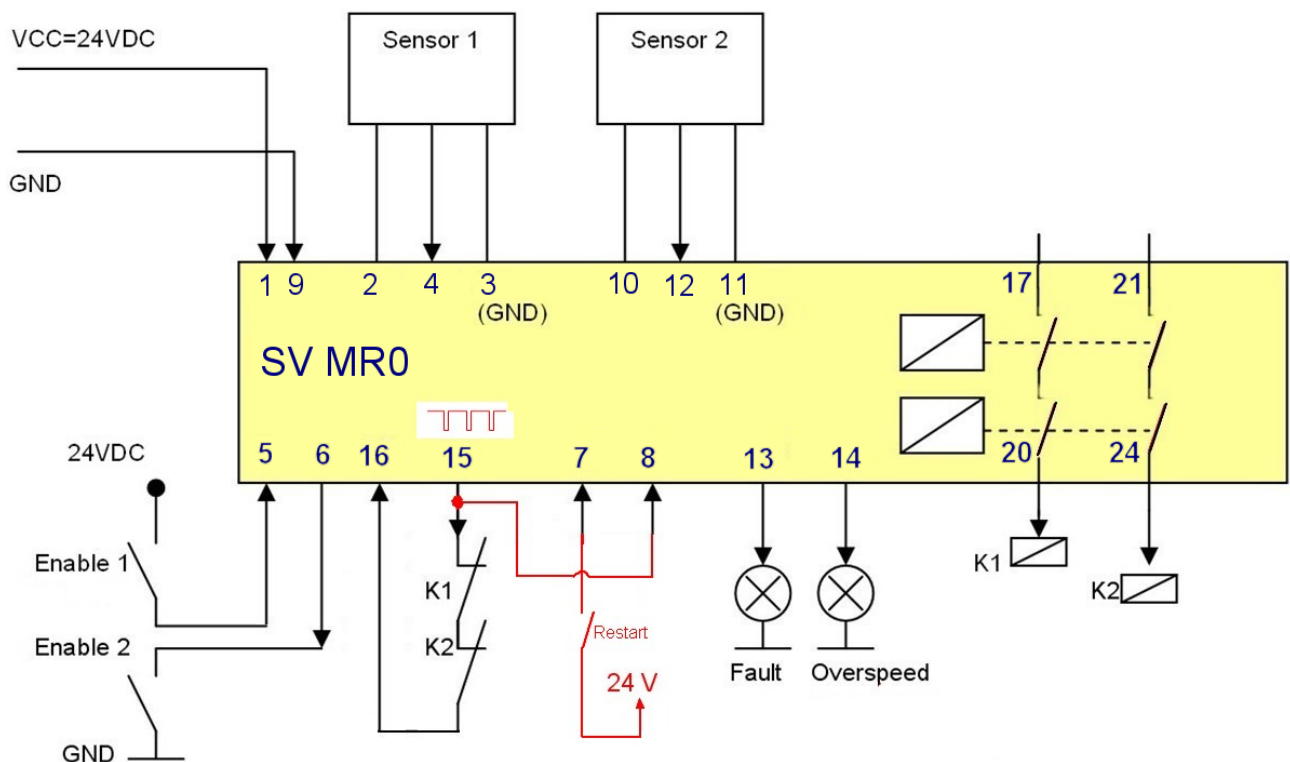

Figure 4 - Manual mode selection

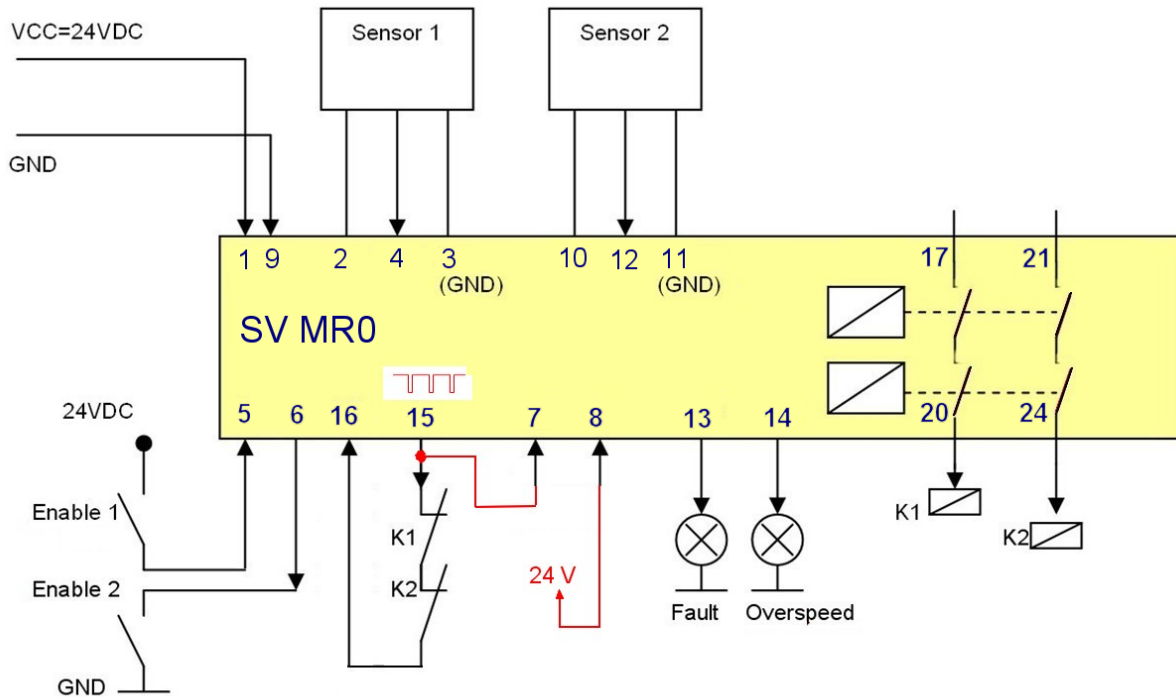

Figure 5 - Automatic mode selection

Automatic mode

In this operating mode, the relay outputs of the safety module check the value of the input frequency comparing it with the selected value:

- > With the input frequency below the selected value the relay outputs are active.
- > With the input frequency above the selected value the relay outputs are deactivated)

When the 7 input is connected to 15 (pulsed output test) and the 8 input is connected to 24VDC, the Automatic mode is selected.

If a failure is detected (short circuit to 0VDC or 24VDC or that connections have been removed) the device will pass to the failsafe status.

Manual mode

In this operating mode, the outputs of the control unit are activated only if the input frequency below the selected value and after sending the RESTART signal to the safety unit using the push-button or by means of a specific command on the RESTART input (terminal 7).

Once the overspeed has been detected, the relay outputs are deactivated.

The sequence described above must be repeated in order to re-activate them.

- > If it is detected during the initialisation that the input 8 is connected to 15 (pulsed output test) and 7 is open then the Manual mode is selected.
- > In this case the relay path remains open until a Restart signal in Input 7 happens. The Restart signal on input 7 will respond after the falling edge (a complete transition 0VDC >> 24VDC >> 0VDC) of this input and this signal will be active only if the frequency is below the F_{OH} value.



The RESTART command must be installed outside the danger area in a position where the danger area and the entire work area concerned are clearly visible.



It must not be possible to reach the control from inside the danger area.



The duration of the Restart signal is also checked from a minimum of 300ms to a maximum of 5sec. Otherwise the command is rejected.



If the Restart command is activated (rising edge or falling edge or both) when the frequency is between FO and FOH the command is also rejected.

When the module is waiting for the restart (clear status) a yellow led (ENA) is blinking indicated this status.

See figure below for a diagram about the manual mode selections.

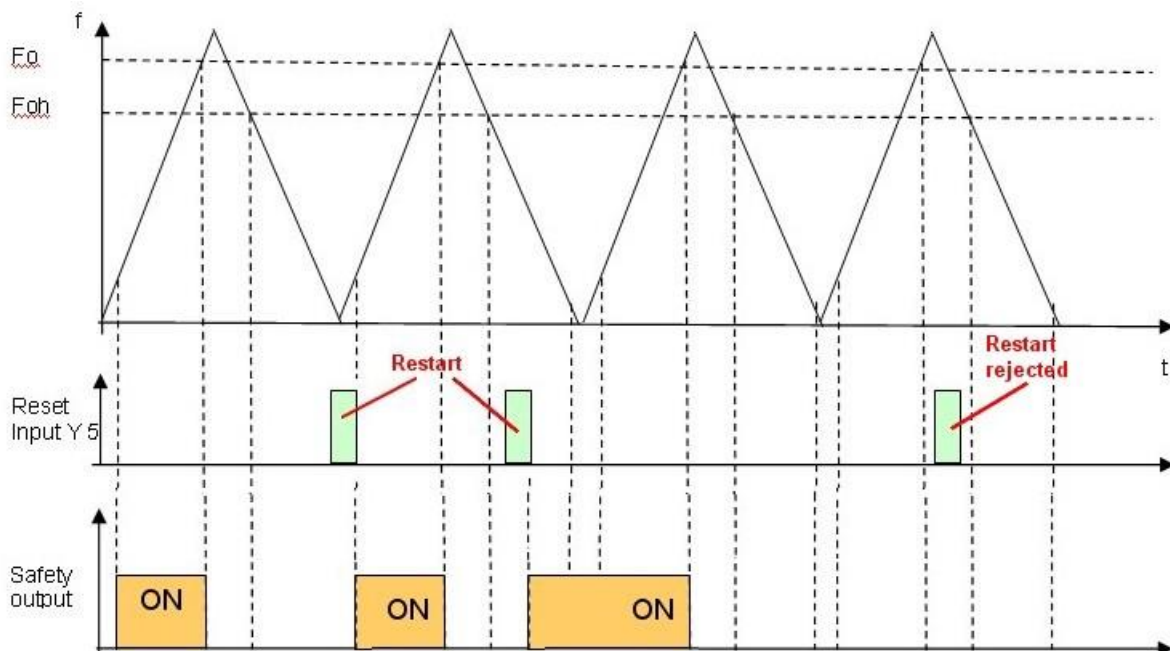

Figure 6 - Manual mode / restart diagram

ENABLE INPUT:

If several modules with different switch points are used for overspeed monitoring of a drive, the devices whose switch point value is not relevant can be "switched off" by means of the *enable* input pairs.

The current paths are then closed. In this way the relay status can be controlled via the *enable* input after power on of the device.

Activation or deactivation is done by means of an antivalent signal to both *enable* inputs.

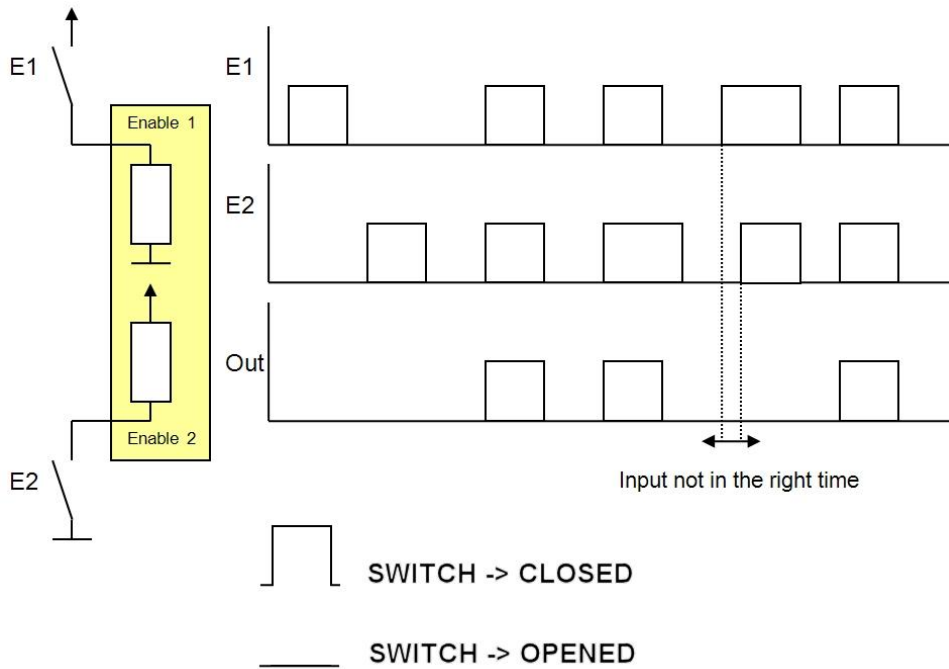

Figure 7 - Enable timing

The signal can be applied via mechanical switches.

In Figure 7 a signal curve is showed.



A maximum of 0.5s of simultaneity between the two input E1 and E2 is allowed.

TECHNICAL DATA SV MRO

Voltage supply		
Supply voltage U_v	24VDC	
Voltage range	80 .. 120 %	
Power consumption	< 3 W	
Device response time (ms)		
$(f_{sel} \geq 100\text{Hz})$	$T_r = 10,7 + 400 \cdot (f_{sel}/f_{in})$	$f_{sel} = \text{selected frequency (by potentiometers)}$
$(f_{sel} < 100\text{Hz})$	$T_r = 14 + (4500/f_{in})$	$f_{in} = \text{input frequency (from proximities)}$
Inputs		
Voltage	24VDC	
Current	typ. 6mA / 24VDC (for HIGH level)	
Max. input frequency	2,000 Hz Min Pulse Width for frequency > 500Hz: 100µs. Min Pulse Width for frequency ≤ 500Hz: 150µs.	
Setting range of the limit speed	0.5 ... 990 Hz	
Speed ranges	10 rpm to 49,500 rpm	
Outputs		
Output function	2 safety-related switching outputs (floating contacts) 1 fault output "FAULT" (positive switching) 1 diagnostic output "OVERSPEED" (positive switching)	
Output data	FAULT (13) and OVERSPEED (14) ≤20mA / 24VDC, voltage drop, ≤2V short-circuit proof, not safe	
Switching function	Outputs 17-20 and 21-24 open if input frequency above switch point Transistor outputs 13 open (LOW) in case of internal/external fault Transistor outputs 14 open (LOW) when current paths are open	
Sensor outputs		
Voltage	24VDC	
Current	≤ 70 mA / 24VDC	
Voltage drop	≤ 2 V	
Diagnostic and fault outputs		
Voltage	24VDC	
Current	≤ 20mA / 24VDC	
Voltage drop	≤ 2 V	
Enabling circuits		
Switching capacity	24VDC , 250VAC / 6mA - 6A, resistive Load	
Protection housing and terminals	IP 20	
Contact protection	3.6A externally	
Max. ambient temperature	-40 .. +55 °C	
Max. storage temperature	-40 .. +70 °C	
Max. altitude (above sea level)	2000 m	
Relative humidity	10% ÷ 95%	
Connection type	terminals blocks	
Housing		
Housing	108 x 22.5 x 114.5	
Standards		
EN ISO 13849 / EN 61508	PL e / Cat. 4; SIL 3;	
RoHS	conform	

TECHNICAL DATA CONCERNING SAFETY*	PFHd (IEC 61508)	HFT (IEC 61508)	MTTFd (EN ISO 13849-1)	DCavg (EN ISO 13849-1)
DC13 (2A)@24Vdc	7,69E-09	1 type B	528,73	99,0%
AC15 (1A) @220Vac	8,25E-09	1 type B	496,36	99,0%
AC15 (3A)@220Vac	9,15E-09	1 type B	451,54	99,0%
Device lifetime	20 years			
Safe state	Output relay open			
Failure response time	5,5 ms			

* Considering 1000 relay operations/year

DEFINITION OF THE LED'S

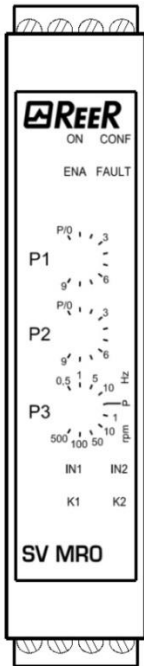

LED		COLOUR
IN2	Input IN2	yellow
IN1	Input IN1	Yellow
K2	Indicator Relay K2	Green
K1	Indicator Relay K1	Green
ENA	Indicator Enable	Yellow
CONF	Indicator Configuration	Blue
ON	Power Indicator	Green
FAULT	Fault Indicator	Red

IN2	Input Sensor IN2 lights, when a high signal at the input IN2 was detected.
IN1	Input Sensor IN1 lights, when a high signal at the input IN1 was detected.
K2	Indicator Relay K2 lights when the safety output relay K2 is switched on.
K1	Indicator Relay K1 lights, when the safety output relay K1 is switched on.
ENA	Indicator Enable lights when the Enable inputs are logical on. In configuration mode this LED blinks rotating the potentiometers (one blink for each step). In clear status (waiting for a restart command) this led blinks. → <i>(Manual Mode)</i>
CONF	ON when device in configuration mode Blinking when switches are in P position.
ON	Indicator ON lights, when the safety module is powered.
FAULT	Indicator Fault lights when an internal fault is detected. Indicator Fault is flashing, when an external fault (i.e. the sensor-test) is detected. → <i>(Faults (Blinkings))</i>

FAULTS (BLINKINGS)

Number of blinkings	Fault
1	MANUAL/AUTOMATIC configuration error
2	Switches incorrect position (frequency selectors)
3	EDM error.
4	<ul style="list-style-type: none"> Proximity error. With IN1/IN2 flashing simultaneously: IN1 or IN2 absent.
5	Overload outputs 2 (sensor1 supply) or 10 (sensor2 supply) or 13 (fault) or 14 (overspeed) or 15 (FBK circuit).

Additional notes

PULSE INPUTS, PULSE PICK-UPS

- ➔ The input signals from proximity must be bounce-free.

SWITCHING OUTPUTS:

- ➔ The NO contacts of the internal relays are connected "in series" so that the current paths are not closed before both relays have switched.

RESTART COMMAND:

- ➔ The duration of the Restart signal is checked from a minimum of 300ms to a maximum of 5sec. Otherwise the command is rejected.

FAULT OUTPUT:

- ➔ The transistor output "Fault" (13) opens when an internal or external error occurs. Output characteristics: max. 100mA, short-circuit proof, non-safe.

OVERSPEED OUTPUT:

- ➔ The Overspeed output (14) is "HIGH" when the current paths are closed and "LOW" when the current paths are opened.
Output characteristics: max. 100mA, short-circuit proof, non-safe.

FEEDBACK CIRCUIT:

- ➔ When overspeed is detected the current paths open and the external relays are de-energised. If the feedback circuit (series on external contactor NC contacts) does not close within 1s there will be an error message (FAULT led lighted on and K1, K2 led blinking).
- ➔ If the feedback function is not required, the terminals (15-16) can be permanently bridged.

Checklist after installation

- ➔ Directly after power on, the SV MRO carries out an initialisation comprising a complete self-test. Anyway to have the system perfect operation perform the following checks at start up and at least every one year:

1. Verify that all the cables are correctly inserted and the terminal blocks well screwed.
2. Verify that all the leds (indicators) light on correctly.
3. Verify the positioning of all the sensors connected to SV MRO.
4. Verify the correct fixing of SV MRO to the Omega rail.
5. Verify that all the external indicators (lamps) work properly.
6. Verify that the potentiometers works correctly.

Application Note

The module checks that the two input frequencies are the same (with the appropriate tolerances), regardless of their phase relationship. This means that in a mono-directional movement of the two speed sensors can be distributed in a free manner along the path of detection.

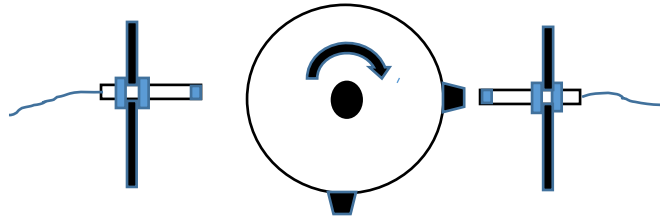

In this case, the proximity switch inputs will have the following behavior:

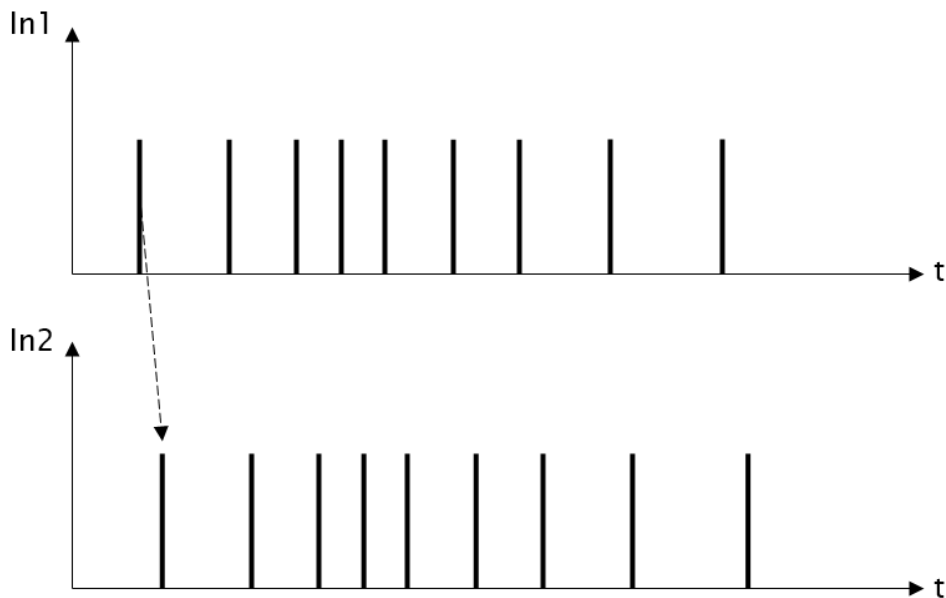

There may be instances wherein the position of the proximity switches becomes important, that is, when there is a movement in two directions, or an oscillation with respect to an axis which, being able to interest a single proximity switch, can lead the module to the fault.

For example:

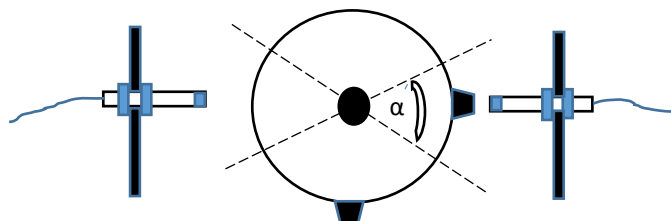

In the figure above with a repeated movement of an angle α the two sensors will read two different frequencies, leading the module in Fault.

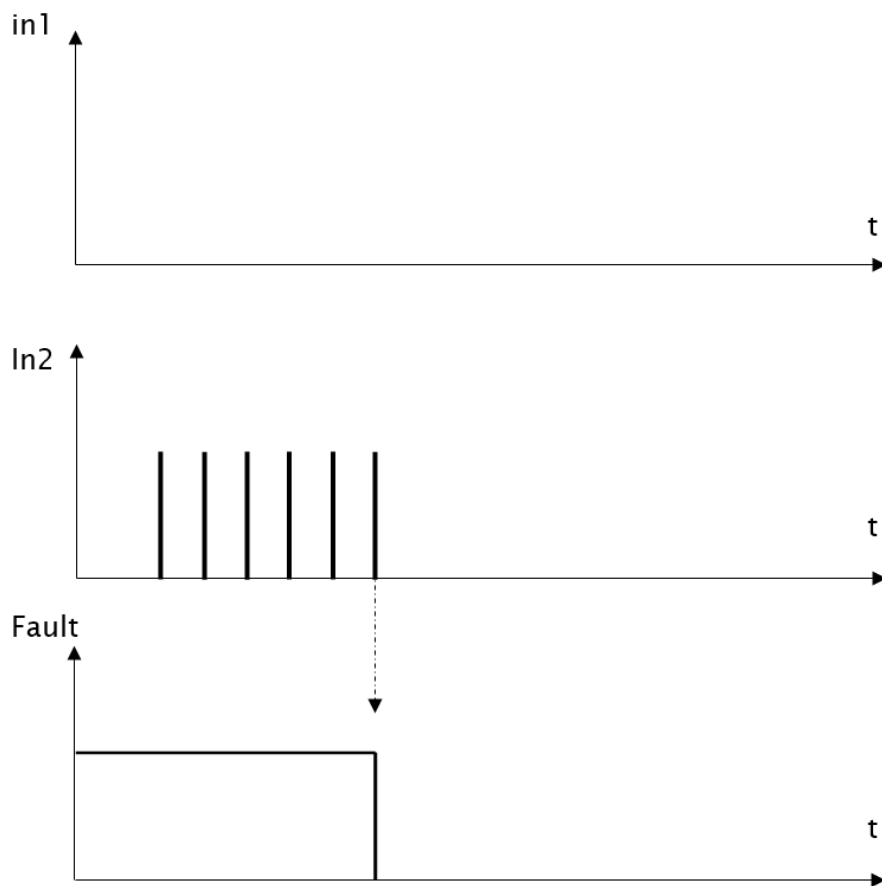

In this case the two inputs will read two different frequencies and the module will go into Fault condition with four flashes of led EXT, IN1 and IN2.
The solution in this case is to change the position of the proximity switch (or of the reference marks) so that the pulses can be detected from both proximities.
See the following figure:

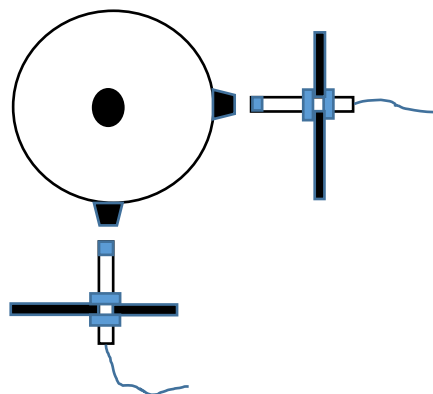

Warranty

ReeR warrants that each SV MRO unit in new ex-factory condition, in conditions of normal use, is free of defects in the materials and of manufacturing defects for a period of 12 (twelve) months.

In this period, ReeR undertakes to eliminate any faults in the product through repair or replacement of the faulty parts, completely free of charge as regards material and labor. However, ReeR reserves the right to replace the entire faulty appliance with another equivalent appliance or with the same characteristics instead of repairing this.

Validity of this warranty is regulated by the following conditions:

- The user must inform ReeR of the fault within twelve months from the date of delivery of the product.
- The appliance and its components must be in the conditions in which they were delivered by ReeR.
- The serial numbers must be clearly legible.
- The fault or defect has not been caused directly or indirectly by:
 - Improper use;
 - Non-compliance with instructions for use;
 - Carelessness, inexperience, incorrect maintenance;
 - Repairs, modifications, adaptations not carried out by ReeR personnel, tampering, etc.;
 - Accidents or impacts (also due to transportation or causes of force majeure);
 - Other causes not to be ascribed to ReeR.

Repairs will be carried out at the ReeR laboratories to which the material must be delivered or dispatched: transport risks and the risks of any damage or loss of the material during shipment are the responsibility of the user.

All products and components replaced become the property of ReeR.

ReeR does not recognize any other warranties or rights except for those specifically described above; therefore, no claims for damages may be submitted for expenses, interruption of business or other factors or circumstances in any way related to failure of the product or of one of its parts.

Precise, complete compliance with all the rules, instructions and prohibitions indicated in this handbook is an essential requirement for correct functioning of the safety interface.

ReeR s.p.a. therefore declines any responsibility for all and anything resulting from failure to comply, even partially, with such indications..

Characteristics subject to change without notice. • Total or partial reproduction is forbidden without the prior authorization of ReeR.

EC DECLARATION OF CONFORMITY



Dichiarazione CE di conformità EC declaration of conformity

Torino, 13/10/2022

REER SpA
via Carcano 32
10153 - Torino - Italy

dichiara che i controllori di velocità SV MR0 / SV MR0U / SV MR0W sono dispositivi di sicurezza realizzati in conformità alle seguenti Direttive Europee:

declares that the SV MR0 / SV MR0U / SV MR0W speed monitors are safety device complying with the following European Directives:

2006/42/EC	"Direttiva Macchine" "Machine Directive"
2014/30/EU	"Direttiva Compatibilità Elettromagnetica" "Electromagnetic Compatibility Directive"
2011/65/EU	"Limitazioni sull'uso di sostanze pericolose nelle Apparecchiature Elettriche ed Elettroniche" "Restriction of the use of certain hazardous substances in Electrical and Electronic Equipment"

ed è conforme alle seguenti norme:

and complies with the following standards:

EN 61131-2 (2007)	Controllori programmabili - Parte 2: Specifiche e prove delle apparecchiature. Programmable controllers - Part 2. Equipment requirements and tests.
EN ISO 13849-1 (2015)	Sicurezza del macchinario: Parti dei sistemi di comando legate alla sicurezza. Parte 1: Principi generali per la progettazione. Safety of machinery:- Safety-related parts of control systems - Part 1: General principles for design.
EN 61496-1 (2013)	Sicurezza del macchinario: Dispositivi Elettrosensibili di protezione, Parte 1: Requisiti generali e tests. Safety of machinery : Electro sensitive protective equipment, Part 1: General requirements and tests.
EN 61508-1 (2010)	Sicurezza funzionale di impianti elettrici/elettronici/programmabili legati alla sicurezza: Requisiti generali. Functional safety of electrical/electronic programmable electronic safety related systems: General requirements.
EN 61508-2 (2010)	Sicurezza funzionale di impianti elettrici/elettronici/programmabili legati alla sicurezza: Requisiti per impianti elettrici/elettronici/programmabili legati alla sicurezza. Functional safety of electrical/electronic/programmable electronic safety related systems: Requirements for electrical/electronic/programmable electronic safety-related systems.
EN 61508-3 (2010)	Sicurezza funzionale di impianti elettrici/elettronici/programmabili legati alla sicurezza: Requisiti Software. Functional safety of electrical/electronic programmable electronic safety related systems: Software requirements.
EN 61508-4 (2010)	Sicurezza funzionale di impianti elettrici/elettronici/programmabili legati alla sicurezza: Definizioni e abbreviazioni. Functional safety of electrical/electronic programmable electronic safety related systems: Definitions and abbreviations.
IEC 61784-3 (2008)	Reti di comunicazione industriali - Profili - Parte 3: Sicurezza funzionale dei bus di campo - Norme generali e profilo definizioni. Industrial communication networks - Profiles - Part 3: Functional safety fieldbuses - General rules and profile definitions.
EN 62061 (2005/A2:2015)	Sicurezza del macchinario. Sicurezza funzionale dei sistemi di comando e controllo elettrici, elettronici e programmabili correlati alla sicurezza. Safety of machinery - Functional safety of safety-related electrical, electronic and programmable electronic control systems.

raggiungendo il livello di sicurezza pari a: **SIL 3 / SILCL 3 / PL e / Cat. 4 (v. standard corrispondenti)**

reaching a safety level corresponding to : **SIL 3 / SILCL 3 / PL e / Cat. 4 (see related standards)**

ed è identico all'esemplare esaminato ed approvato con esame di tipo CE da:

and is identical to the specimen examined and approved with a CE - type approval by:

TÜV SÜD Product Service GmbH – Zertifizierstelle – Ridlerstraße 65 – 80339 – München – Germany

N.B. number: 0123 – Certificate No. Z10 024820 061 Rev.1

Responsabile per la documentazione tecnica:

Responsible person for technical documentation:

Carlo Pautasso

Carlo Pautasso
Direttore Tecnico
Technical Director

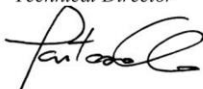

Simone Scaravelli
Amministratore Delegato
Managing Director

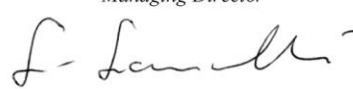

UKCA DECLARATION OF CONFORMITY

ReeR declares that Safety Speed Monitor SV MR0 complies with following UK legislation:

- S.I. 2008 No. 1597 - The Supply of Machinery (Safety) Regulations
- S.I. 2016 No. 1101 - Electrical Equipment (Safety) Regulations
- S.I. 2016 No. 1091 - Electromagnetic Compatibility Regulations
- S.I. 2012 No. 3032 - The Restriction of the Use of Certain Hazardous Substances in Electrical and Electronic Equipment Regulations



Please refer to the link <https://www.reersafety.com/certifications/> to download the complete UKCA Declaration of Conformity.



Via Carcano, 32
10153 Torino, Italy
T +39 011 248 2215
F +39 011 859 867
www.reersafety.com
info@reer.it

